

# the garden knapsack sprayer

product  
manual

12 & 16  
litre models



**HILLS.**<sup>TM</sup>

## Warning

This sprayer is designed for domestic use only with water based garden chemicals.

Not to be used for any other purpose. To be used by adults only.

**Important:** Under normal use and conditions the sprayer bottle has a maximum life of five (5) years after purchase date.

The purchase date, place of purchase and product number should be recorded in this Product Manual.

## Spare Parts

**FH2I5427** – Nozzle and Lance Kit

## Accessories

**FH2I5410** – Cone Spray Shield and Cup

**FH2I5403** – Lawn Edger Shield

A single nozzle is included for use instead of the twin nozzle. The single nozzle has two types of spray patterns. One is for a mist spray pattern and one is for a jet spray pattern.

Choose the one suitable for your particular spraying application.

An extension lance **E** (page 5) is included for longer reach.

## Safety Instructions

**Caution:** Contents under pressure. Read this before operating.

- Release pressure from the sprayer unit before refilling or replacing parts. This is done by pressing the on/off trigger and letting out as much air or liquid as possible through the lance and nozzle assembly.

**Note:** Even though the bottle may have no liquid left inside, the actual pump chamber may still contain residual fluid in it.

To empty the residual fluid, press and lock the on/off trigger for continuous spraying, then pump handle for a few times and ensure that all liquid and air is fully expelled before unscrewing either the container or pump cap.

- Inspect the condition of all fittings before each use. Replace any worn or damaged parts. Do not attempt to use with damaged or suspect parts.
- The sprayer is made from different types of plastic material, and although the liquid you may wish to use is packed in a plastic container, it is not guaranteed that it will not damage the sprayer. The sprayer is designed to be used with a broad range of domestic water based pesticides, herbicides, and fertilisers. The use of heavy duty industrial strength chemicals may be detrimental to the safe operation of the sprayer.
- For correct chemical usage follow chemical suppliers on-pack instructions.

## Do's

- ✓ Release pressure before filling/servicing
- ✓ Release pressure and clean after use
- ✓ Wear safety goggles and gloves
- ✓ Wear protective clothing and mask
- ✓ Spray water soluble chemicals
- ✓ Ensure adequate ventilation
- ✓ Wash hands and face after use
- ✓ Store away from sunlight
- ✓ Hand tighten fittings only
- ✓ Rinse inside of bottle before use
- ✓ Read and understand chemical manufacturers' safety directions

## Don'ts

- ✗ Spray flammable liquids or solvents
- ✗ Eat, drink or smoke when spraying
- ✗ Direct spray on humans or animals
- ✗ Spray in windy conditions
- ✗ Spray in confined spaces
- ✗ Leave within reach of children
- ✗ Overfill the bottle
- ✗ Over pressurise
- ✗ Stand sprayer near naked flame or hot surfaces
- ✗ Tighten fittings with pliers etc.
- ✗ Allow children to use as a toy
- ✗ Modify bottle or safety valve
- ✗ Leave bottle unattended, especially if containing chemicals

Please retain this Product Manual. Record the following information for future reference.

Product Number (printed on carton): \_\_\_\_\_

Date of purchase: \_\_\_\_\_

Name and location of store: \_\_\_\_\_



Designed and tested under a  
Quality System that meets Hills  
demanding quality specifications.

Made in China

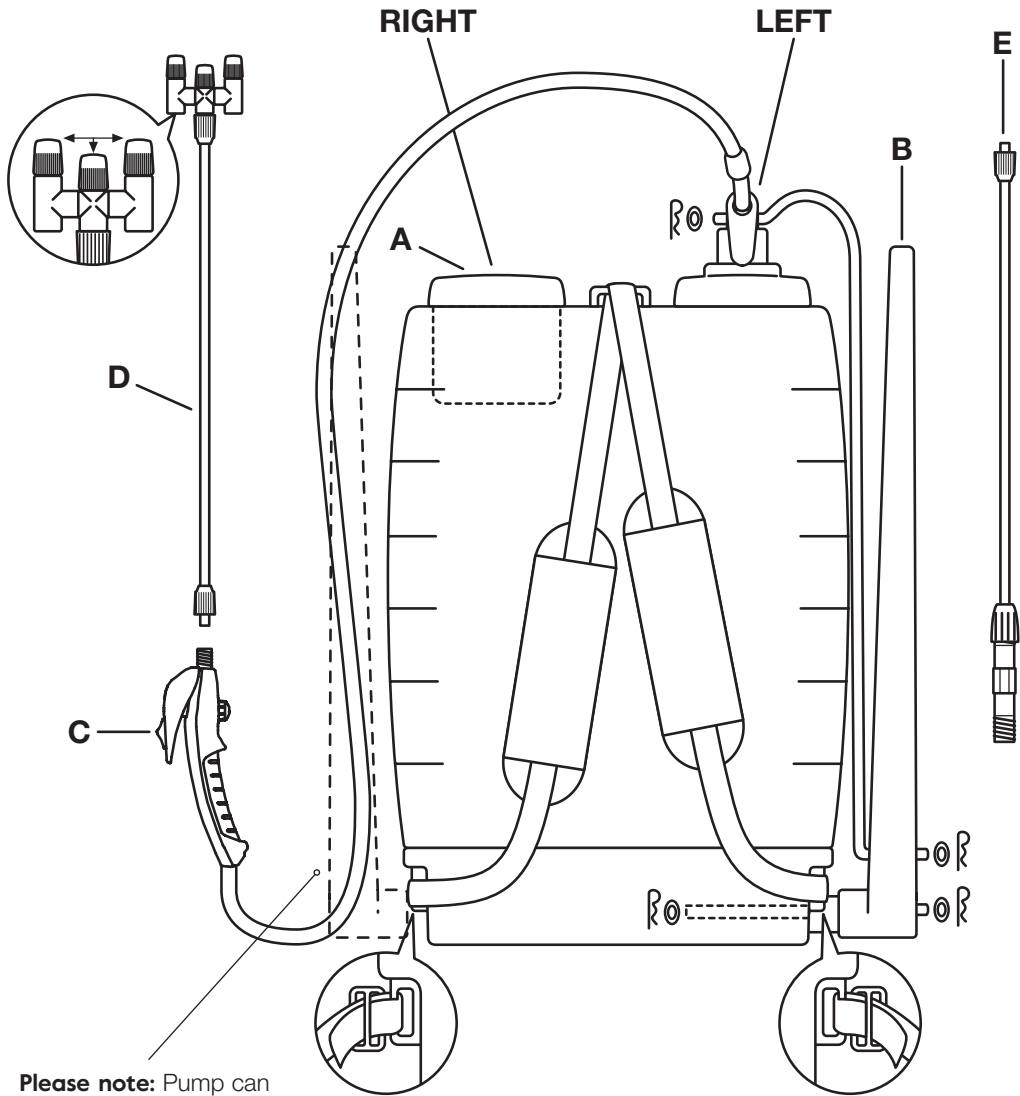

**Please note:** Pump can be assembled for left or right handed operation.

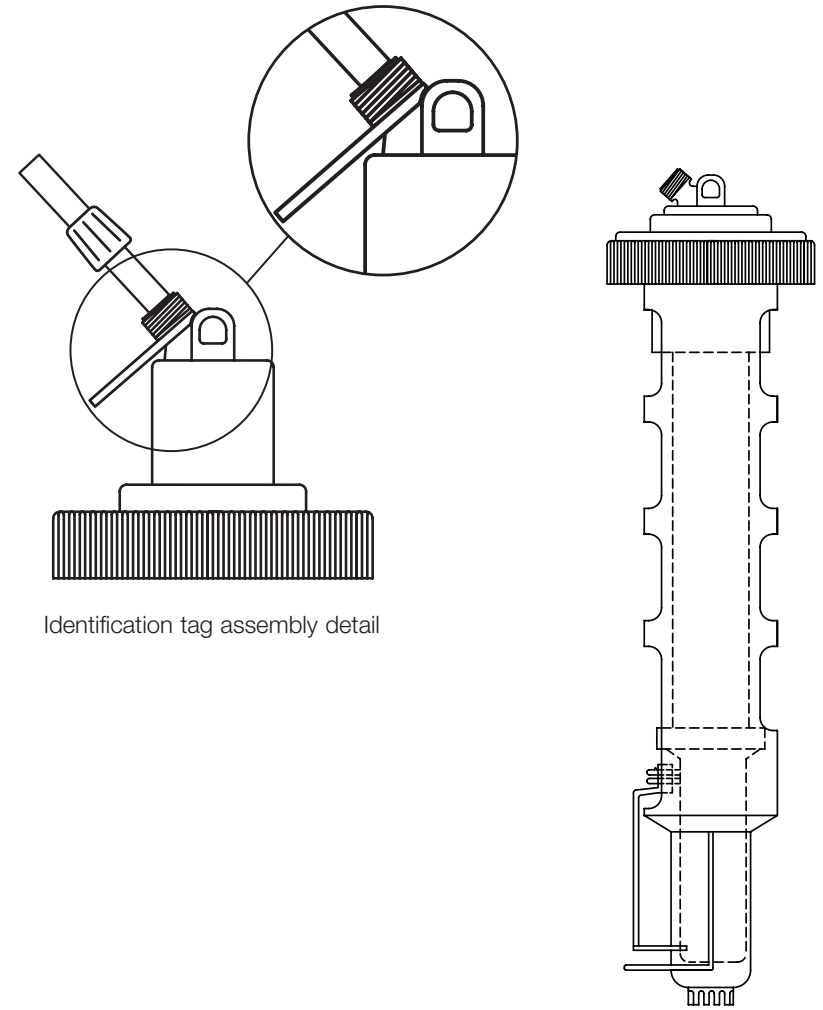

**Please note:** The diagram above depicts the internal pump assembly for reference purposes only.

## Operating Instructions

**Important:** Rinse the inside of the container with cold water before use. Before using any chemicals including herbicides, pesticides, insecticides and weed killers etc., it is advisable to familiarise yourself with the sprayer operation by filling it with water and testing the various spray patterns. Thick mixtures can clog the spray nozzle. Solutions of this kind should be strained and diluted to prevent blockages. Wash the container, all attachments and your hands thoroughly after each use.

- Refer to diagram for assembly guidance.
- Left or right-handed operation can be achieved by changing the pump mechanism from position **LEFT** to position **RIGHT**.
- Unscrew container cap **A** and fill liquid to the required level. Ensure that filter is sitting inside bottle as shown on diagram. **DO NOT** exceed the 12L mark on the 12L Knapsack Sprayer or the 16L mark on the 16L Knapsack Sprayer.
- Replace container cap **A** and tighten firmly by hand. Make sure that the other container cap is also tight to prevent air escaping during use.
- Firmly screw Lance Assembly **D** to the Handle Assembly **C**.
- Adjust straps for comfort.
- Pump handle **B** and start spraying by pressing the on/off trigger on handle assembly **C**. The handle assembly is equipped with a lock for continuous spraying. Press trigger and slide it forward until locked. To unlock, slide the trigger back and release it.
- Pump handle periodically to maintain pressure for ongoing spray flow.
- Adjust the twin nozzles for required spray pattern. To use only single nozzle, replace any of the two outside nozzles with the centre nozzle cap.

## After Use

- Release pressure from the sprayer unit before refilling or replacing parts. This is done by pressing the on/off trigger and letting out as much air or liquid as possible through the lance and nozzle assembly.
- After you have ensured the sprayer contains no pressure, remove the container cap **A** and empty any liquid left inside the container.

**Note:** Even though the bottle may have no liquid left inside, the actual pump chamber may still contain residual fluid in it.

To empty the residual fluid, press and lock the on/off trigger for continuous spraying, then pump handle a few times and ensure that all liquid and air is fully expelled.

- Refill the bottle with approximately 2 litres of clean tap water, then with the on/off trigger pressed and locked for continuous spraying, pump handle and start expelling all the water until empty.
- Make sure that the sprayer is not pressurised and contains no liquid. Do not store in direct sunlight and store out of reach of children. Refer to detailed safety instructions on page 3.

**Important:** Ensure all caps are securely and firmly tightened. After tightening, check that hose and lances do not slip out.

## Maintenance Advice

Over a period of time herbicides and insecticides can leave a build up of residue which normal cleaning will not remove. This build up can collect around the seals and inside the hoses and pump. If left, this build up will eventually prevent the sprayer from working.

To overcome this problem we recommend that the sprayer bottle be half filled with hot (not boiling) water from your domestic hot water supply. By keeping the on/off trigger pressed and locked for continuous spraying, pump handle and start expelling all the water until empty.

The hot water should dissolve the built up residue and the sprayer will continue to operate normally.

**Important:** For safety, ensure you wear protective clothing, goggles and gloves during this operation.

**Important:** If for some reason your sprayer needs to be returned for warranty purposes, PLEASE wash it out thoroughly to protect our service technicians from exposure to unknown substances.

## Single Nozzle

Your sprayer comes with an additional single nozzle attachment for controlled spraying.

- To fit single nozzle, remove the twin nozzle. Refer to **Fig. 1**.
- Fit single nozzle. Refer to **Fig. 2**.

**Fig. 1**

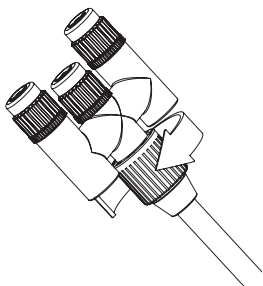

**Fig. 2**

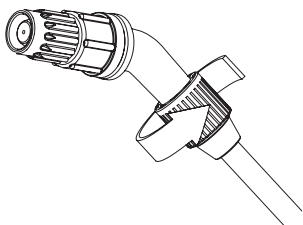

## Strip Spray

Your sprayer comes with an additional strip spray nozzle attachment to aid in controlled spraying.

- To fit strip spray, remove the green nozzle from the grey attachment cap. Refer to **Fig. 3 and 4**.
- Remove the nozzle from cap. Refer to **Fig. 5**.
- Re-assemble the two green halves of nozzle and store safely.
- Place strip spray nozzle into rear of attachment cap along with filter. Refer to **Fig. 6**.
- Replace assembly onto end of nozzle elbow. Refer to **Fig. 7**.

**Fig. 3**

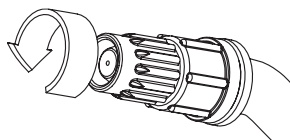

**Fig. 4**

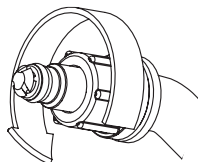

**Fig. 5**

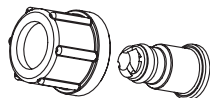

**Fig. 6**

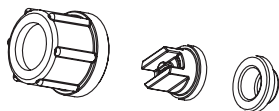

**Fig. 7**

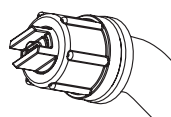

## Substance Identification Tag

- Your Hills Knapsack Sprayer comes with a substance identification tag allowing you to quickly and easily identify what substance is inside your sprayer.
- For your convenience the tag comes with a sheet of pre-printed inserts that display common spraying substances.
- The sheet comes with a number of blank inserts that allow you create your own personalised tags. **Note:** Use a permanent marker when writing on the inserts to prevent writing coming off.

### To Fit Inserts:

- Open the folding lid by unclipping the two side located snaps.
- Fit required insert with the text facing upwards (towards folding lid).
- Snap folding lid back into closed position to secure.

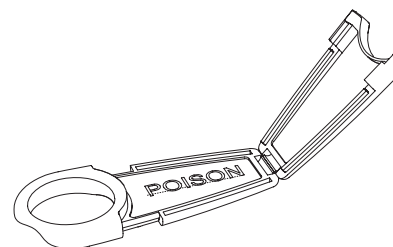
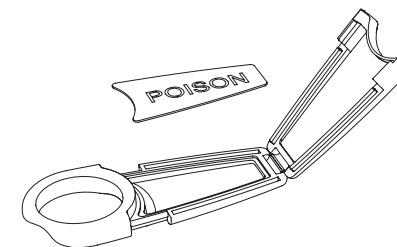
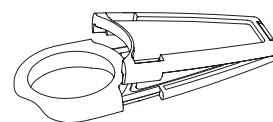

1. Hills provides consumers with the following warranty in relation to this Product, in addition to complying with the requirements of any relevant legislation, including the Competition and Consumer Act 2010 (Cth) in Australia and the Consumer Guarantees Act 1993 in New Zealand (the **Acts**), except where a New Zealand consumer acquires the relevant product for the purposes of a business.
2. In this warranty, we have used the following definitions:
  - (a) **Hills, our or we** means Hills Holdings Limited (ABN 35 007 573 417) of 159 Port Road Hindmarsh South Australia 5007;
  - (b) **Products** means the following goods manufactured by Hills (including products manufactured for Hills by its contract manufacturers):  
**Hills Knapsack Sprayers;**
  - (c) **Material** means a material or component used by Hills in the manufacture of the Products;
  - (d) **Warranty Period** means 3 years from the date of purchase of the relevant Product. If the Product or part (as the case may be) is repaired or replaced, there will be no extension to the original warranty period; and
  - (e) **Workmanship** means the handling, assembly and manufacturing processes performed by or on behalf of Hills in order to manufacture the Products.
3. Hills warrants that for the duration of the Warranty Period, all Products will be free of faults arising from defects in Workmanship or Materials, on the terms and conditions set out in this warranty.
4. Hills undertakes that if during the Warranty Period any Product, or any part of a Product, has failed to operate correctly due to faulty Workmanship or defective Material, it will repair or replace the Product or part (as the case may be) free of charge provided that the following procedure is met:
  - (a) The consumer must contact Hills upon becoming aware of any defect to a Product. The contact details for Hills are set out in this warranty and under the heading "Hills Contacts".
  - (b) Following consultation with Hills, Hills will determine whether there is a defect, and if so Hills agrees to (at Hills' option):
    - i. in the case of goods – repair, replace or supply equivalent goods, or pay the cost of any of those remedies to the consumer; or
    - ii. in the case of services – supply the services again or pay the cost of having the services supplied again.
  - (c) If Hills requests the return of the applicable Product or part, Hills will be responsible for the collection and freight costs of returning that Product or part. The consumer agrees to assist Hills with any reasonable request to enable Hills to collect such Product or part.
  - (d) Hills also agrees to be responsible for the freight costs to deliver any new Product or replacement part to the consumer.

5. This warranty is in addition to any non-excludable legal rights or remedies conferred on the consumer under any applicable Act and any similar laws. To the extent permitted by law, Hills' liability for any non-excludable condition or warranty is limited to rectifying any defect at its option, as set out in paragraph 4(b).
6. Subject to the requirements of any applicable Act or legislation and to the extent permitted by law, no liability (whether expressed or implied) of any nature whatsoever, is accepted by Hills for any consequential loss, damage or injury arising as a result of any fault in the Products.
7. This warranty does not extend to damage to Products which occurs during transit or transportation, or which is caused by any abuse, accident or improper installation, connection, use, adjustment or repair or use of goods otherwise than in accordance with instructions issued by Hills.
8. The warranty on Products is waived if any addition or attachment to the Products do not have Hills' specific approval or are not sold as Hills products. The Products are designed to perform specific tasks under established test loads and unauthorised attachments may produce stresses for which the design is not appropriate.
9. The following applies to consumers who purchased a relevant Product in Australia:
 

Our goods come with guarantees that cannot be excluded under the Australian Consumer Law. You are entitled to a replacement or refund for a major failure and compensation for any other reasonably foreseeable loss or damage. You are also entitled to have the goods repaired or replaced if the goods fail to be of acceptable quality and the failure does not amount to a major failure.

## Hills Contacts

We are committed to providing you with complete customer satisfaction. If you have any questions or comments about our products or services please contact your nearest Customer Service Centre during their local business hours:

**Australia**  
1300 300 564  
info@hills.com.au

**New Zealand**  
09 262 3052  
sales@hills.co.nz

**Rest of the World**  
Refer to Hills Website  
www.hills.com.au/en/contact-us

### Hills Websites

**www.hillshome.com.au**  
Hills Branded Products

**www.hillsholdings.com.au**  
Hills Holdings Limited

**Hills Holdings Limited**

A.B.N. 35 007 573 417

Issue August 2013

PH1158g

**HILLS.**<sup>TM</sup>